

**WHEELIE BIN
COVER DOUBLE**

WHEECO06 - 145x87x129cm

ASSEMBLY INSTRUCTION

READ IN FULL BEFORE COMMENCING ASSEMBLY

Warning

*This product is very heavy. Two people are required for assembly and moving.
ALWAYS LIFT THE FURNITURE WHEN MOVING.*

Product information

Your furniture is manufactured using FSC pine from Europe. It has been treated with preservative to protect against decay, giving a lifespan in excess of ten years. The furniture will have knots and other natural features in the timber. Under normal circumstances pine cracks; this is due to these natural characteristics, and will not compromise the strength of your furniture; which is designed with this in mind. We strongly recommend a once yearly application of a water repellent preservative to protect against fungal attack and blackening of the wood. Alternatively use timber sealer.

Maintenance

Your furniture can be cleaned using soapy water and a stiff brush, allowing it to dry fully before the application of any timber treatment. More severe stains such as spillages, bird droppings and mildew etc. can be removed by the use of a cleaner. Alternatively use a medium grit sandpaper.

ATTENTION

This product is very heavy and requires TWO PEOPLE to turn it into the upright position.

ALWAYS LIFT THE FURNITURE WHEN MOVING

ALWAYS LIFT the furniture when moving.

Step 11

Using the small hook at the end of the lid support, screw on the lid support to achieve the desired lid opening.

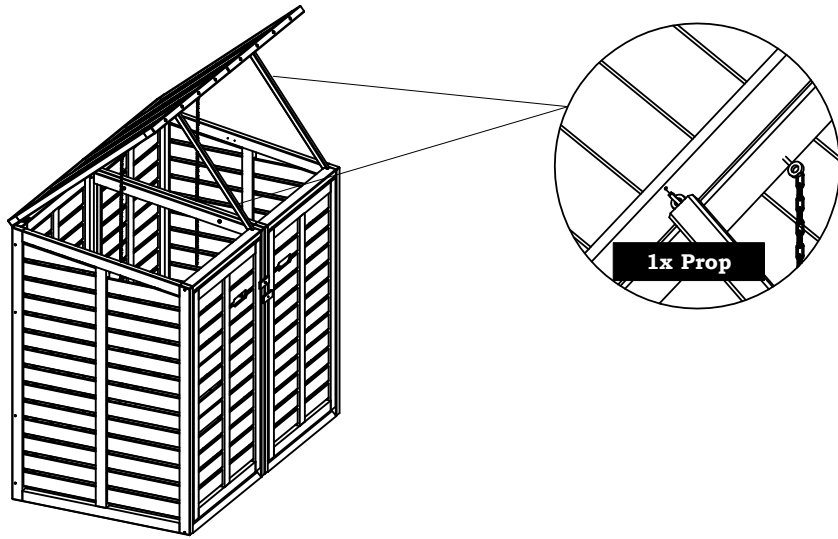

Below are the contents of two boxes (left and right hand box) which make a Double Bin Enclosure. It's easier if you keep the contents of each box separate. You'll need a cross head screwdriver and two people.

Whats included in the box:

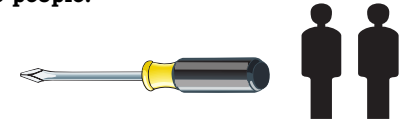

Box 1/2 LEFT

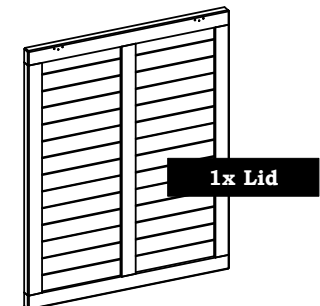
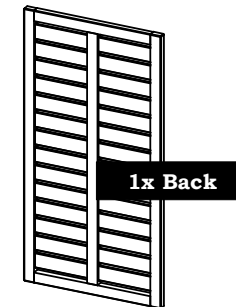
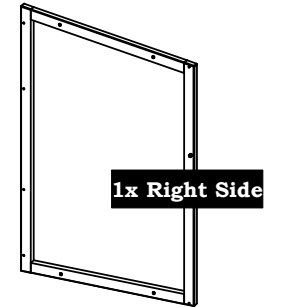
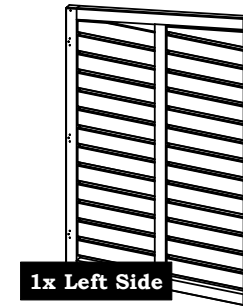
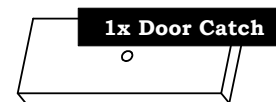
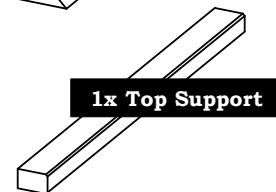
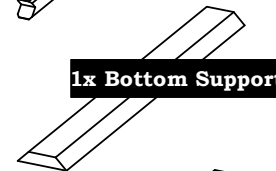
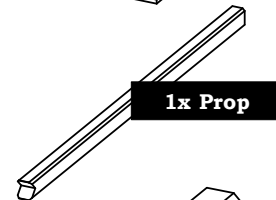

Whats included in the box:

Box 2/2 RIGHT

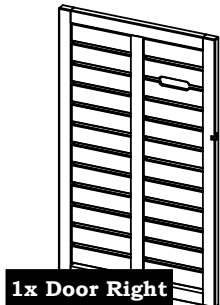
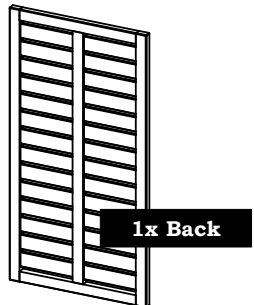
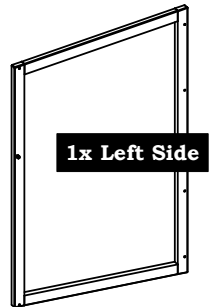
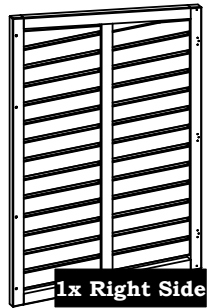
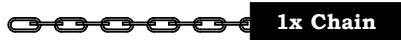
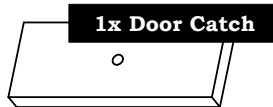
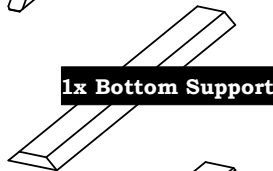
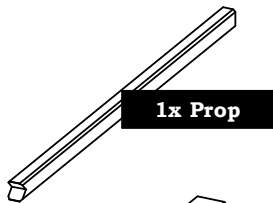
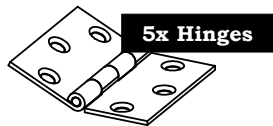

Step 9
Fasten the "Lid" by screwing it on two hinges with 6x SMALL SCREWS in each hinge.
Repeat the step for the other Lids.

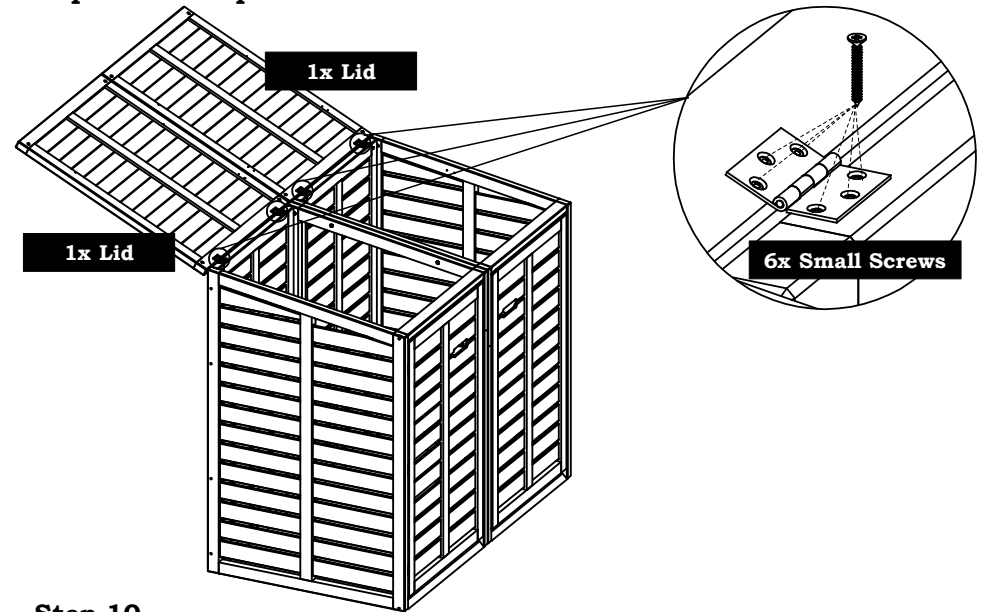

Step 10
Screw DOOR Catch on front of wheelie bin cover to opposite side from hinges, using 1 SMALL SCREW in preferred position.
Repeat the step two times.

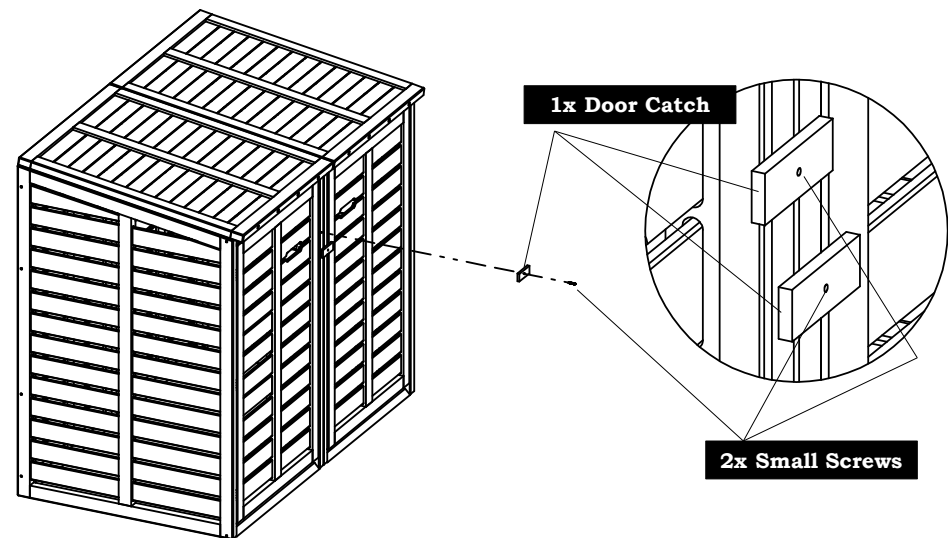

Step 7
 Screw together all two parts (left,right), using 4 Medium Screws

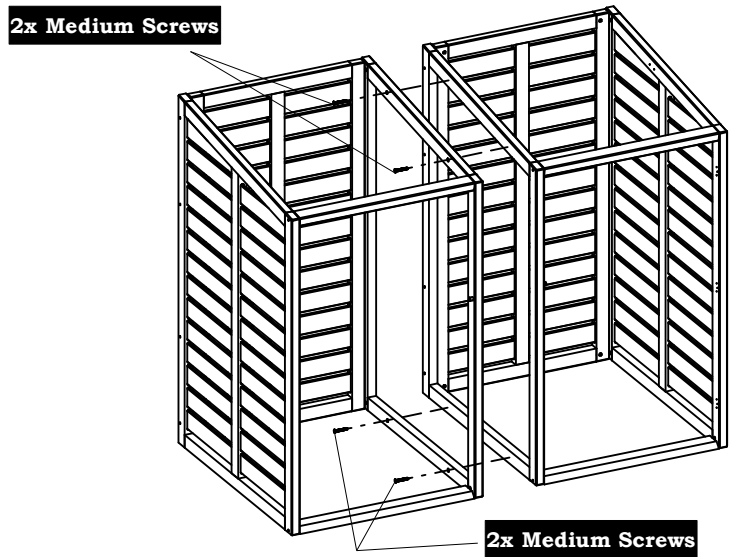

Step 8
 Attach „ 2x Front Door”(1x Door Left; 1x Door Right). Screw one door on with 18x SMALL SCREWS. Repeat two times.

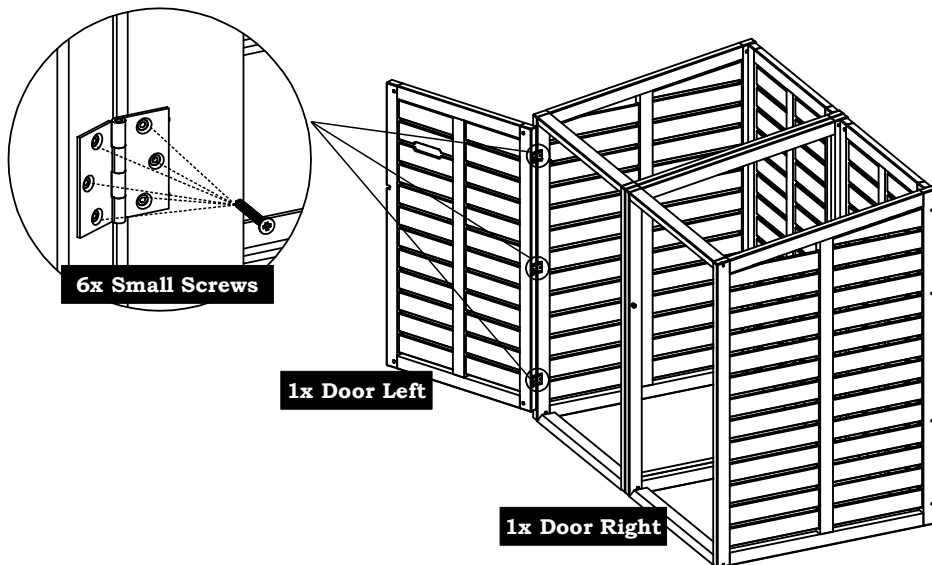

Step 1 - Box 1/2 LEFT
 Position „Back” upright and align one slatted „Left Side”. Secure together using 4 LARGE SCREWS

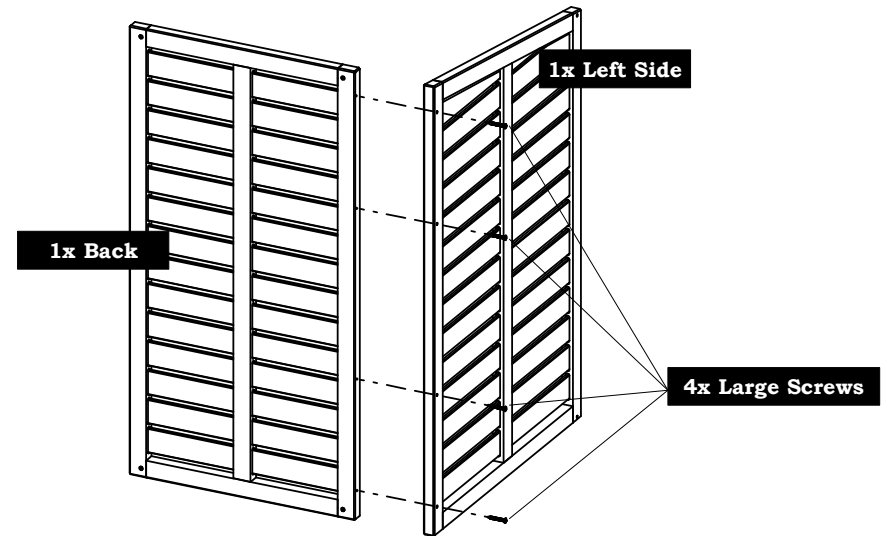

Step 2 - Box 1/2 LEFT
 Position „Back” upright and align one slatted „Right Side”. Secure together using 4 LARGE SCREWS

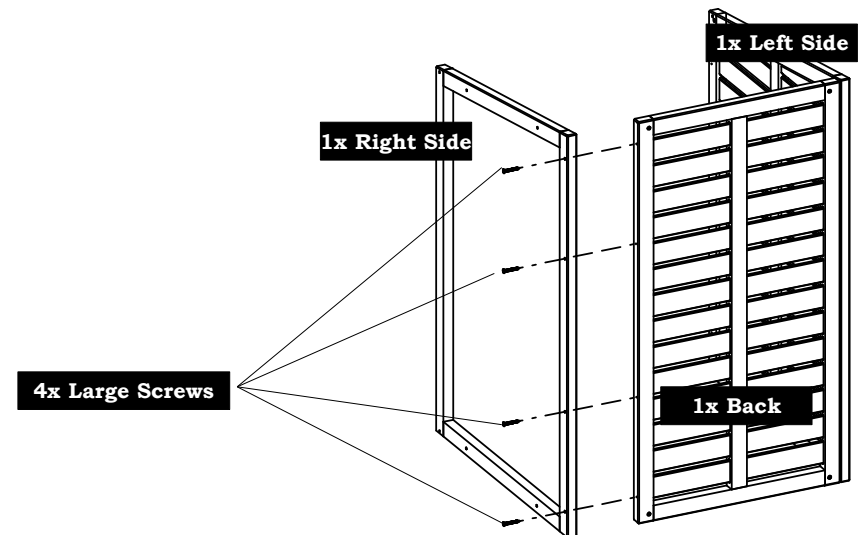

Step 3 – Box 1/2 LEFT

Attach „Top Support”. Secure together using 2 LARGE SCREWS

Attach „Bottom Support”. Secure together using 2 LARGE SCREWS

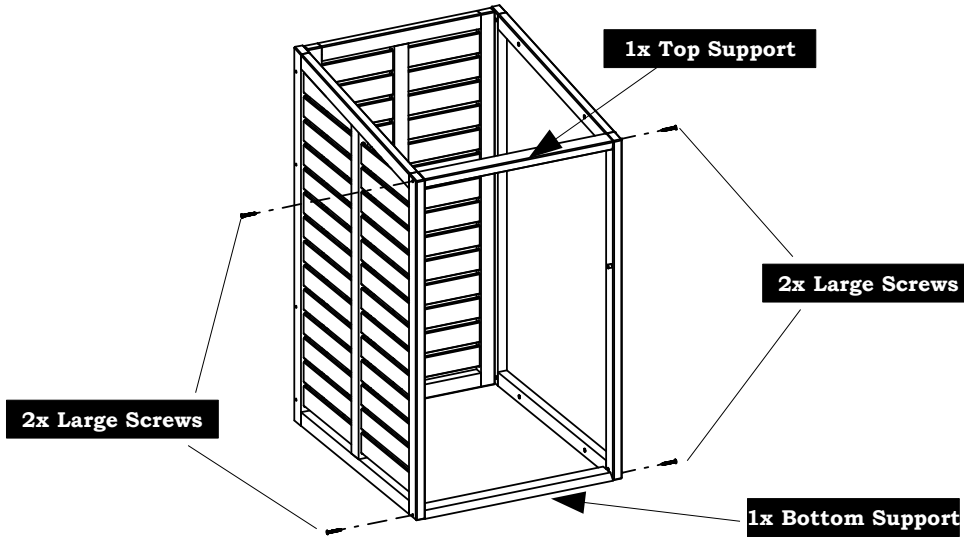

Step 4 – Box 2/2 RIGHT

Position „Back” upright and align one slatted „Left Side”. Secure together using 4 LARGE SCREWS

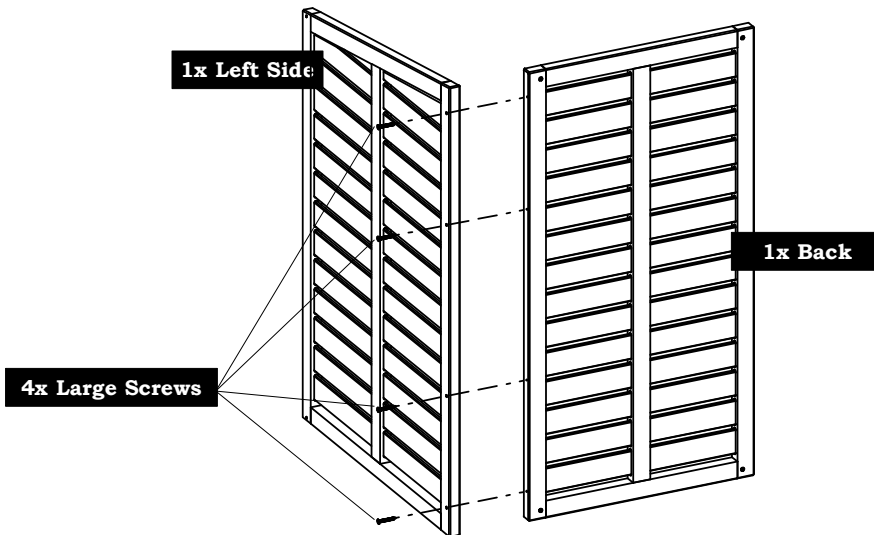

Step 5 – Box 2/2 RIGHT

Position „Back” upright and align one slatted „Right Side”. Secure together using 4 LARGE SCREWS

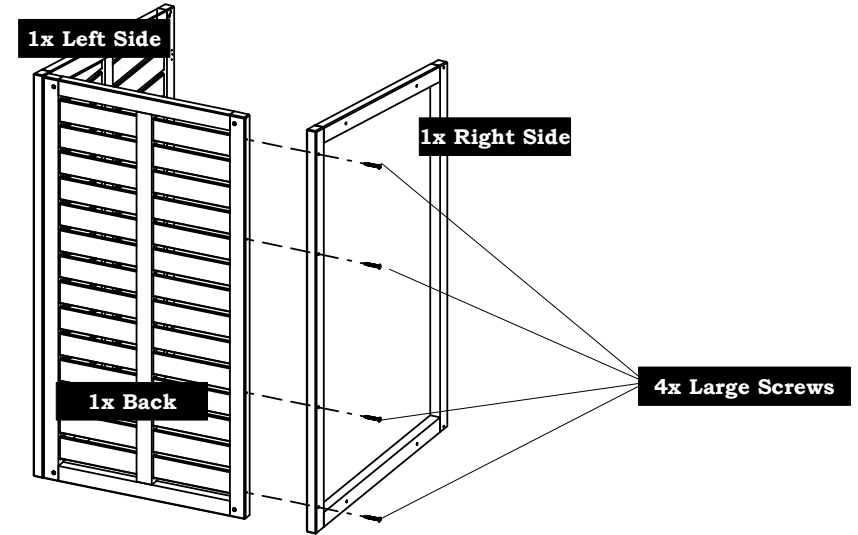

Step 6 – Box 2/2 RIGHT

Attach „Top Support”. Secure together using 2 LARGE SCREWS

Attach „Bottom Support”. Secure together using 2 LARGE SCREWS

