













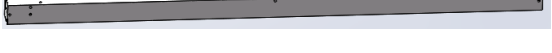



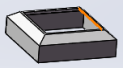
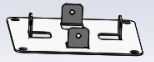













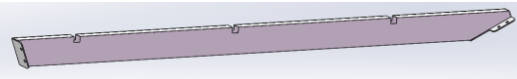
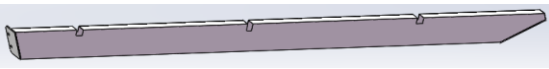
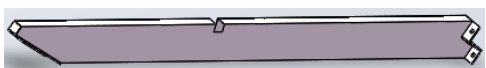
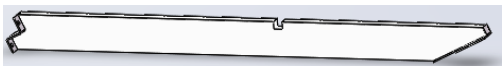





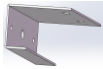
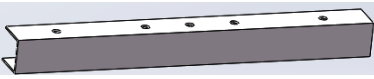







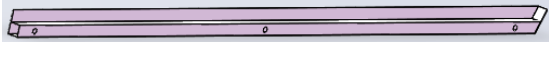







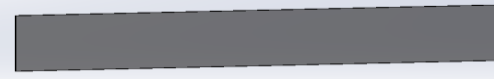



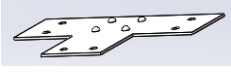

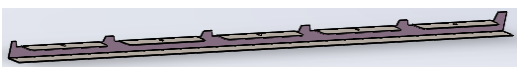

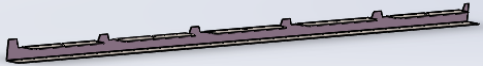
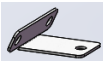

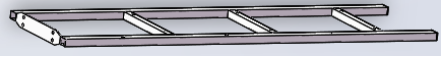

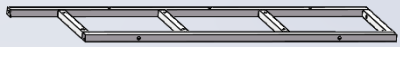

Bar And Grill Gazebo



Label	Description	Qty	Part Image
A1	Pole 1	1	
A2	Pole 2	1	
A3	Pole 3	1	
A4	Pole 4	1	
A5	Pole 5	1	
A6	Pole 6	1	
A7	Upper Pole 1	1	
A8	Upper Pole 2	1	
B	Hook	1	
C	Pole cover	6	
D	Stake base	6	
E1	Short Side Beam 1	1	
E2	Short Side Beam 2	1	
E3	Short Side Beam 3	1	
E4	Short Side Beam 4	1	
E5	Long Side Beam 1	2	
E6	Long Side Beam 2	2	
F1	Support Bar 1	1	
F2	Support Bar 2	1	



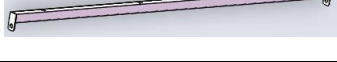



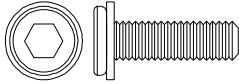

F3	Support Bar 3	1	
F4	Support Bar 4	1	
F5	Support Bar 5	1	
F6	Support Bar 6	1	
G	Support Bar Connector	12	
J1	Long Sloping Beam 1	1	
J2	Long Sloping Beam 2	1	
J3	Short Sloping Beam 1	1	
J4	Short Sloping Beam 2	1	
K1	Beam Connector	2	
L1	PC board 1	1	
L2	PC board 2	1	
L4	Top Beam 3	1	
L5	Top Beam 4	1	
K2	PC board Lower Connector	1	
K3	Lower Roof top beam Connector	1	
M1	Lower Roof Middle Beam 1	2	
M2	Lower Roof Middle Beam 2	1	
M3	Higher Roof Middle Beam 1	1	
M4	Higher Roof Middle Beam	2	

M5	Bar Table Middle Connector	3	
M6	Bar Table L/R Connector	6	
N1	Middle Beam Lower Connector	6	
P1	Side Beam 1	1	
P2	Side Beam 2	1	
P3	Side Beam 3	1	
P4	Side Beam 4	1	
Q1	Small Beam 1	4	
Q2	Small Beam 2	4	
Q3	Lower Small Beam 1	3	
Q4	Lower Small Beam 2	3	
R1	PC Board	2	
R2	“U” Shape Connector	4	
S1	Long Side Roof Panel	5	
S2	Short Side Roof Panel	5	
T1	Beam Corner Cover	4	
T2	Beam Middle Cover	2	
U1	Lower Baffle 1	2	
U2	Lower Baffle 2	2	
U3	Lower Baffle 3	1	

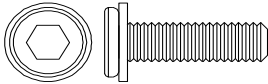
U4	Lower Baffle 4	1	
N2	"L" Shape Middle Beam Connector	3	
V	Side Screen	8	
W1	Table Middle Support Panel	1	
W2	Table Side Support Panel 1	1	
W3	Table Side Support Panel 2	1	
X1	Lower Table top	6	
X2	Upper Table top	2	
Y4	Table Front Panel	4	
AA	Upper Tabletop Connector	1	
AB	Back Support Tube	1	
U2	Side Panel	12	
U3	Long Panel Lower Connector	2	
U4	Long Panel Upper Connector	2	
U5	Middle Panel Lower Connector	1	
U6	Middle Panel Upper Connector	1	
U7	Short Panel Lower Connector	2	
U8	Short Panel Upper Connector	2	
AC	Connector	2	

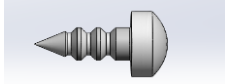

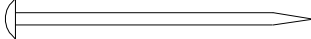

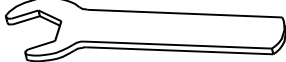



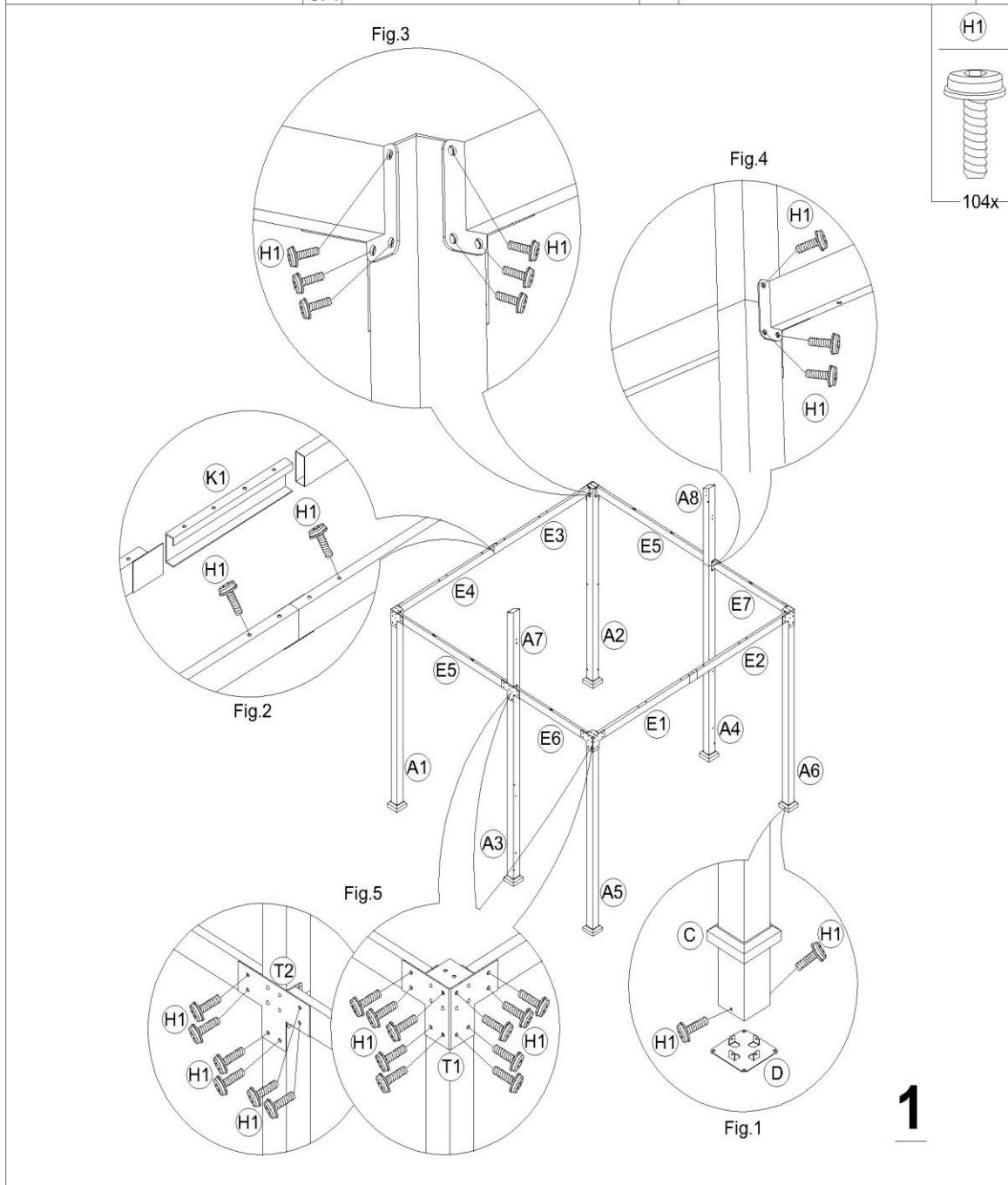

Hardware Pack

Label	Part Number	Description	Qty	Add	Part Image
-------	-------------	-------------	-----	-----	------------





H1		Bolt M6*20	348	7	
H2		Bolt M6*60	8	2	
H4		Bolt M6*35	6	-22	
H5		Nut M6	6	2	
H6		ST M4*10	4	0	
		Flat Washer M6	372	-15	
HS		Stake $\Phi 8*180$	12	0	
HW1		Allen Key M6	1	0	
HW2		Wrench M6	1	0	

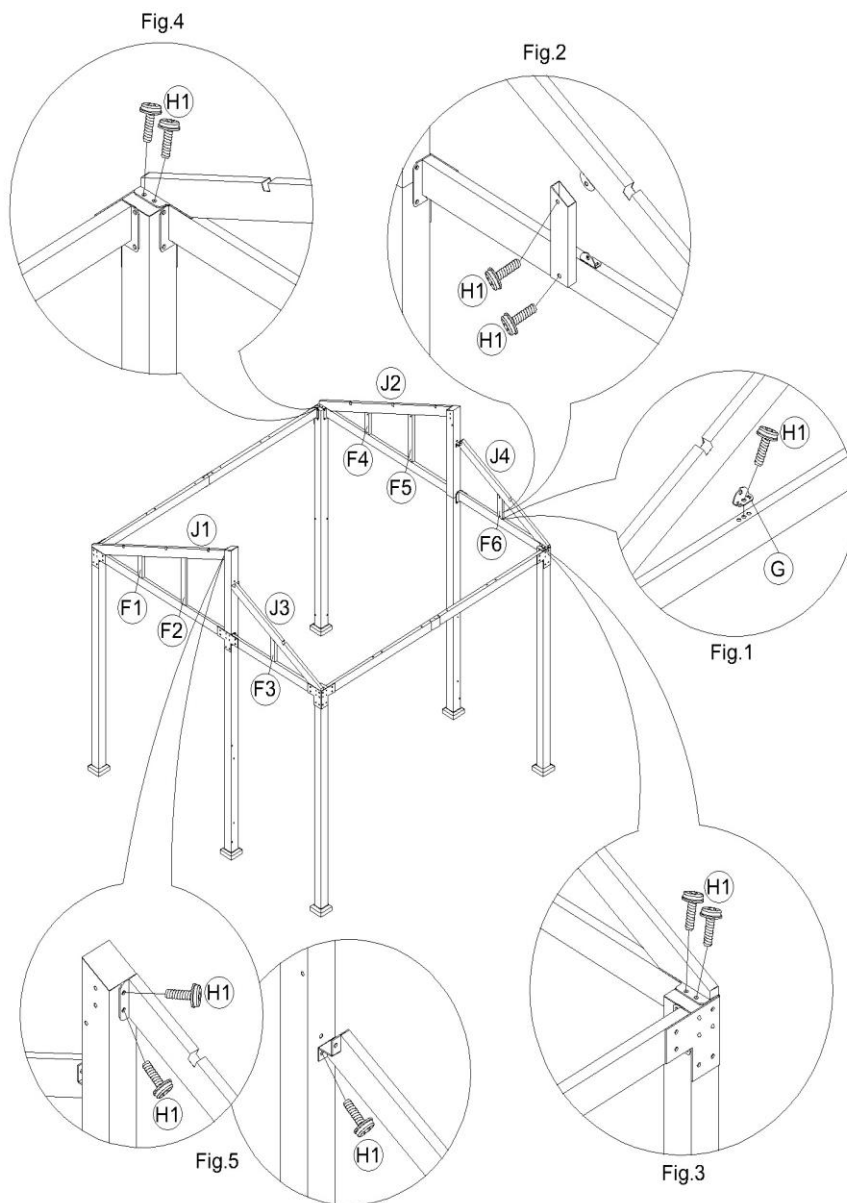

	A1 1X		A2 1X		A3 1X
	A4 1X		A5 1X		A6 1X
	A7 1X		A8 1X		E1 1X
	E2 1X		E3 1X		E4 1X
	E5 2X		E6 2X		K1 2X
	T1 4X		T2 2X		C 6X
	D 6X				







	J1 1X		J2 1X		J3 1X
	F1 1X		F2 1X		F3 1X
	F4 1X		F5 1X		F6 1X
	G 12X		H1 38x		



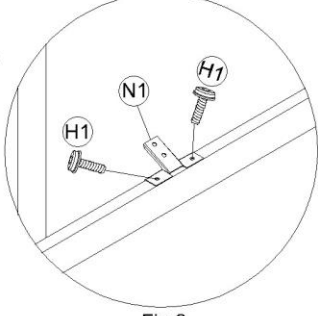
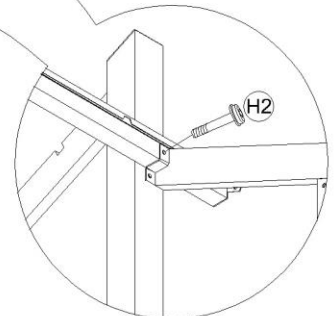
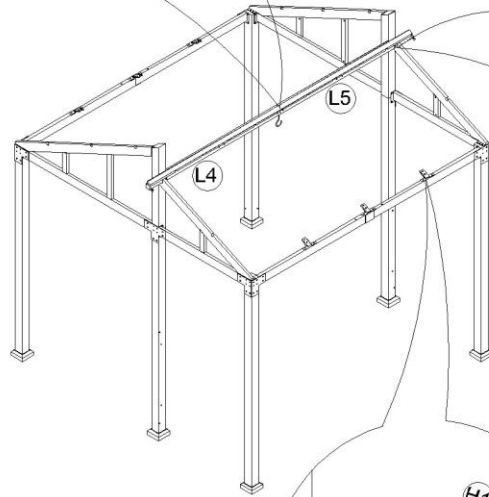
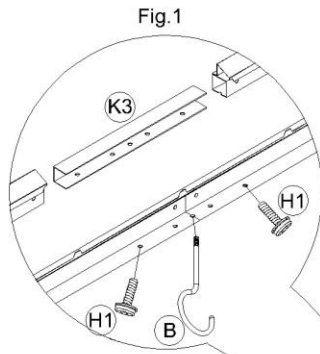

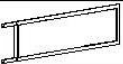



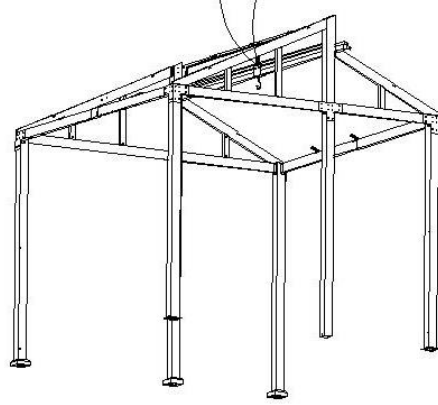
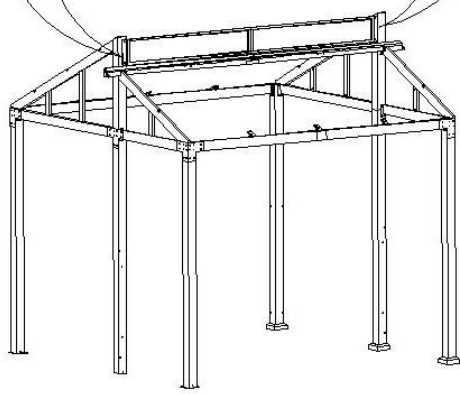
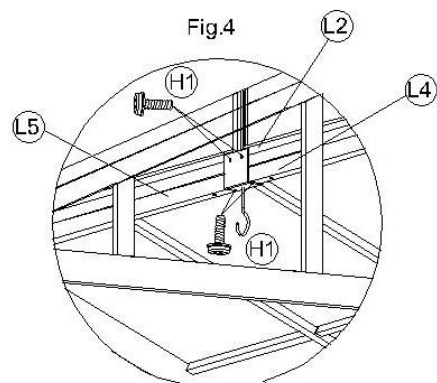
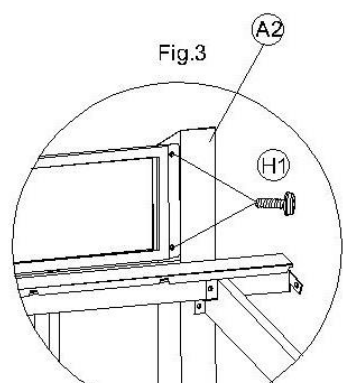
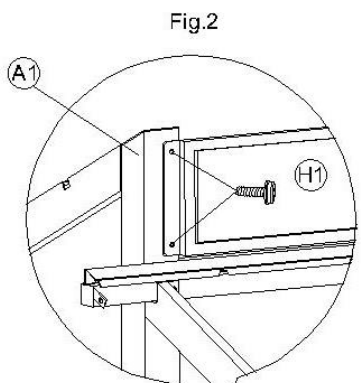
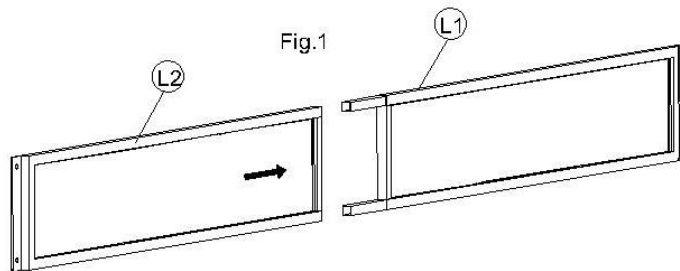
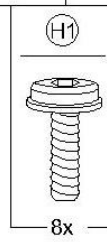

	L4 1X		L5 1X		K3 1X
	N1 6X				

	H2		H1
2x		14x	









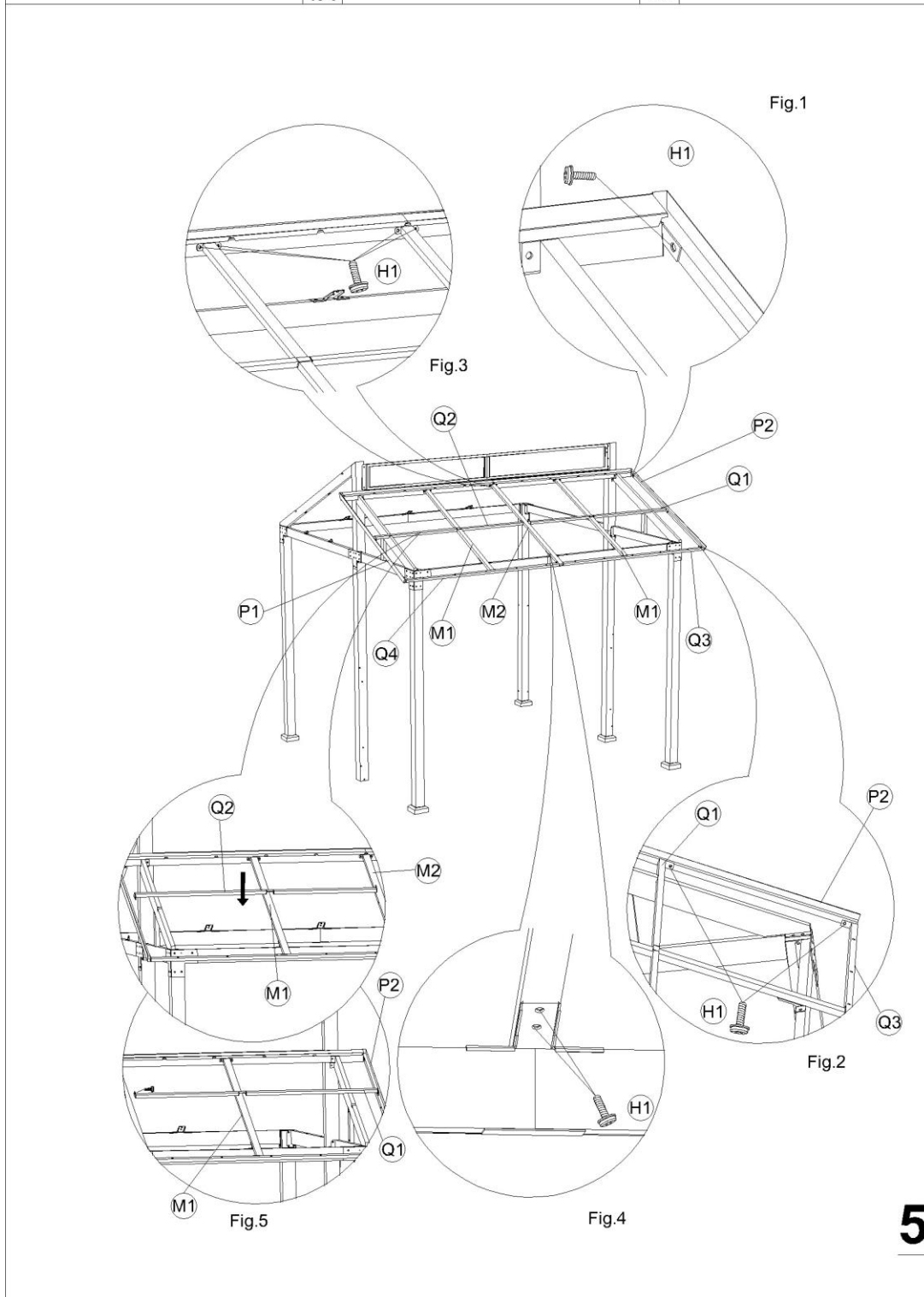
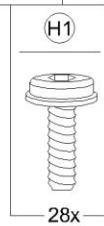

	L1 1X		L2 1X		K2 1X
	B 1X				



	P1 1X		P2 1X		M1 2X
	M2 1X		Q1 1X		Q2 1X
	Q3 1X		Q4 1X		



	P3 1X		P4 1X		M3 1X
	M4 2X		Q1 3X		Q2 3X
	Q3 2X		Q4 2X		

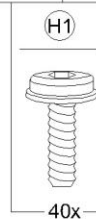

Fig.2

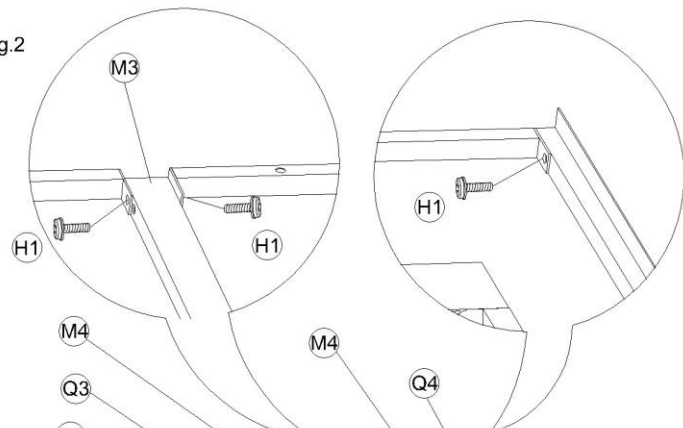

Fig.1

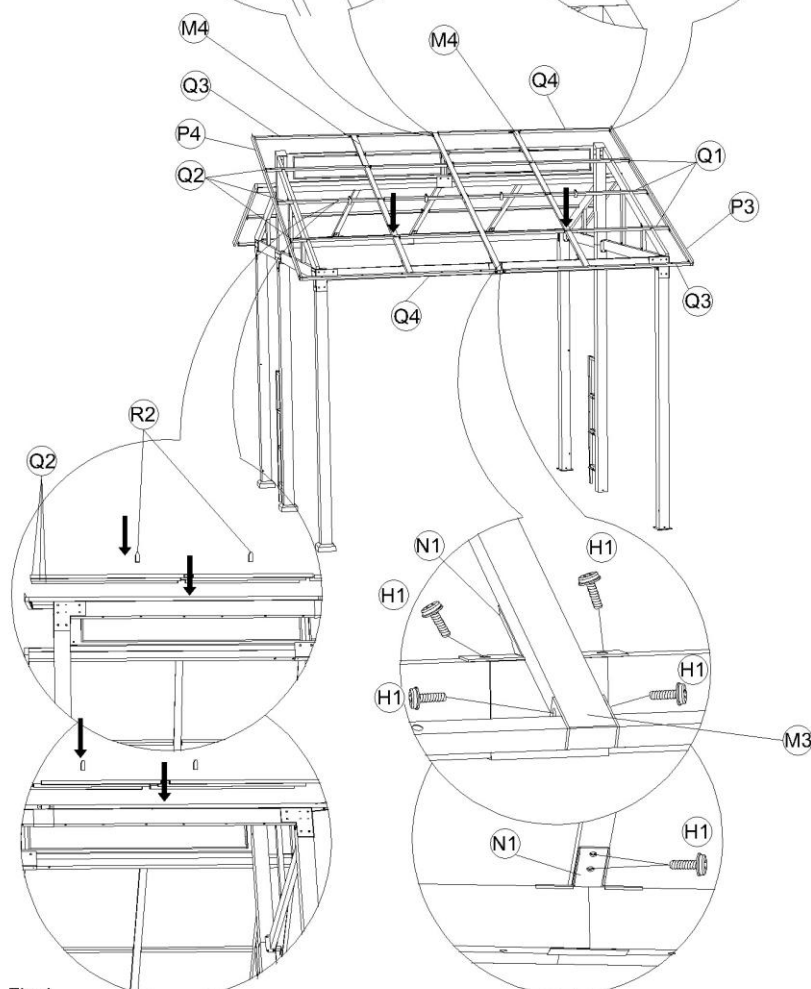
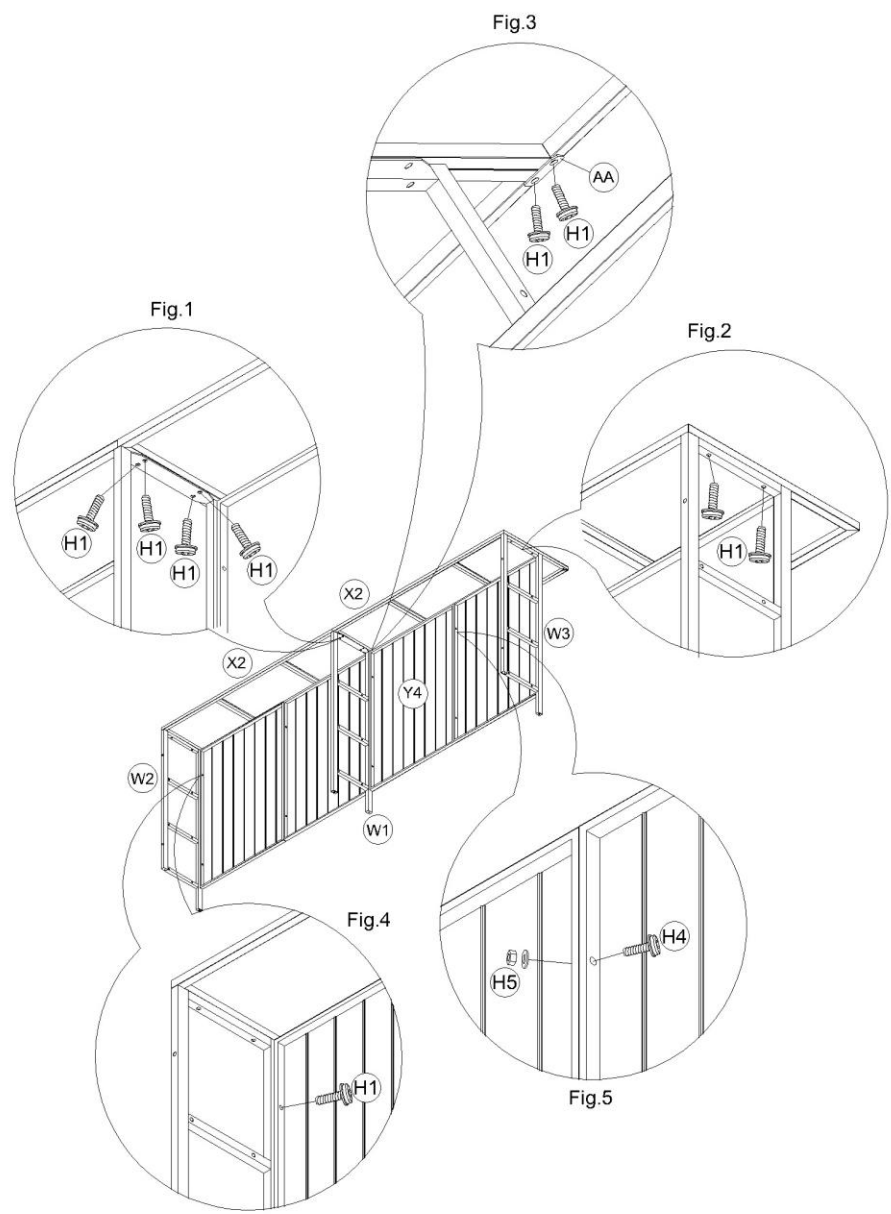

Fig.4

Fig.3

	W1 1X		W2 2X		W3 1X
	AA 1X		X2 2X		Y4 4X

6x	6x	10x





X1
6X



M5
3X



M6
6X

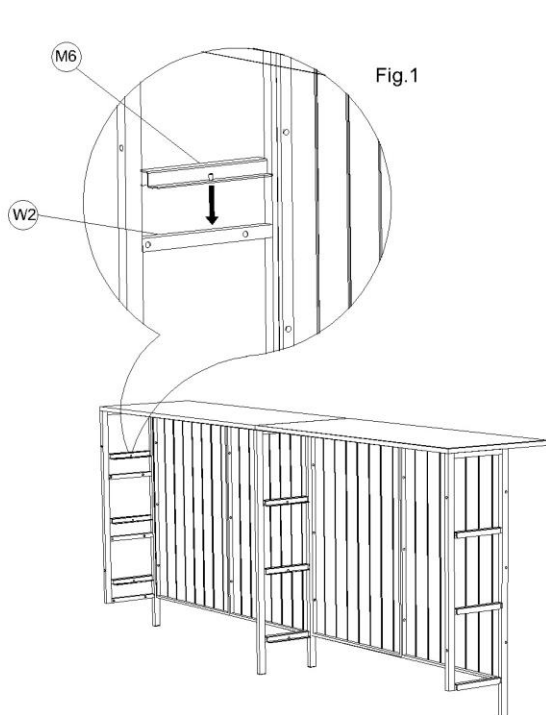

Fig.1

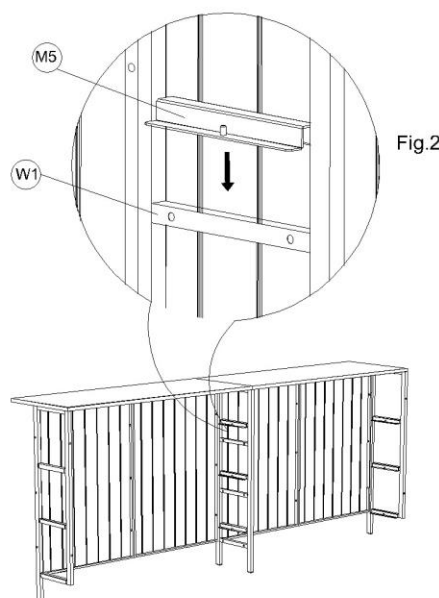

Fig.2

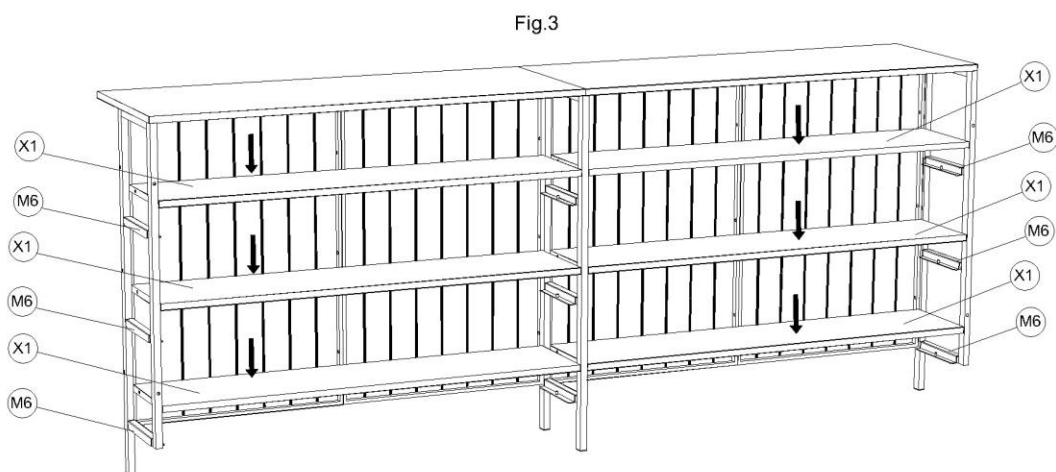

Fig.3

H2



6x

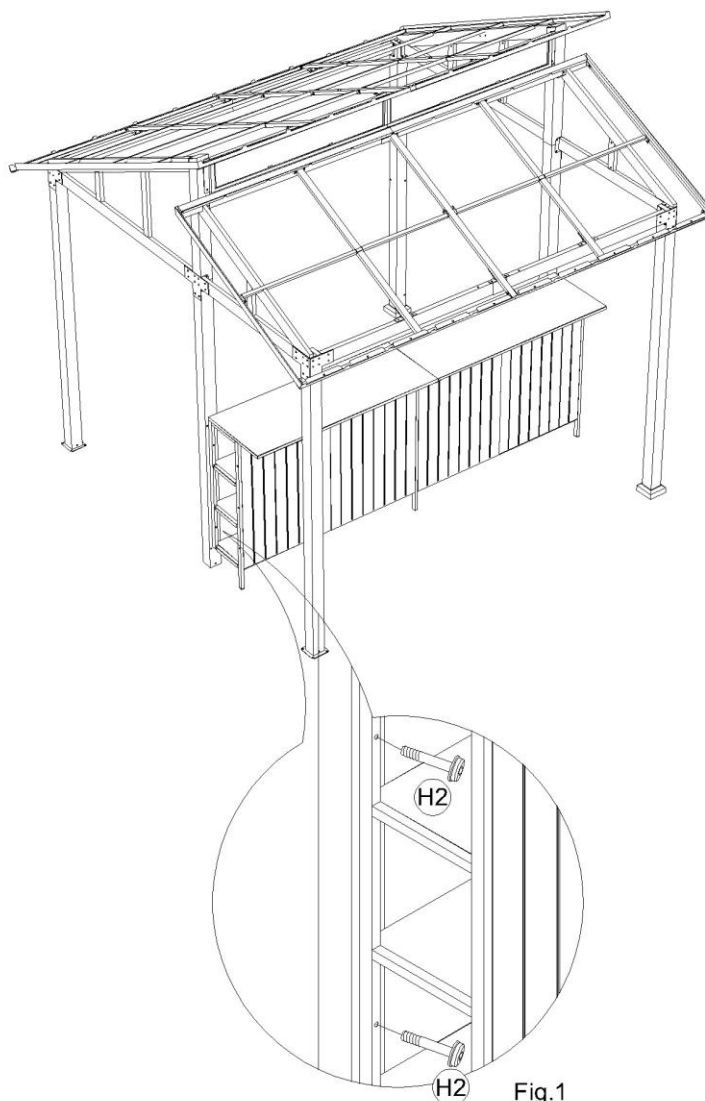
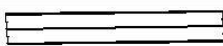





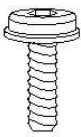
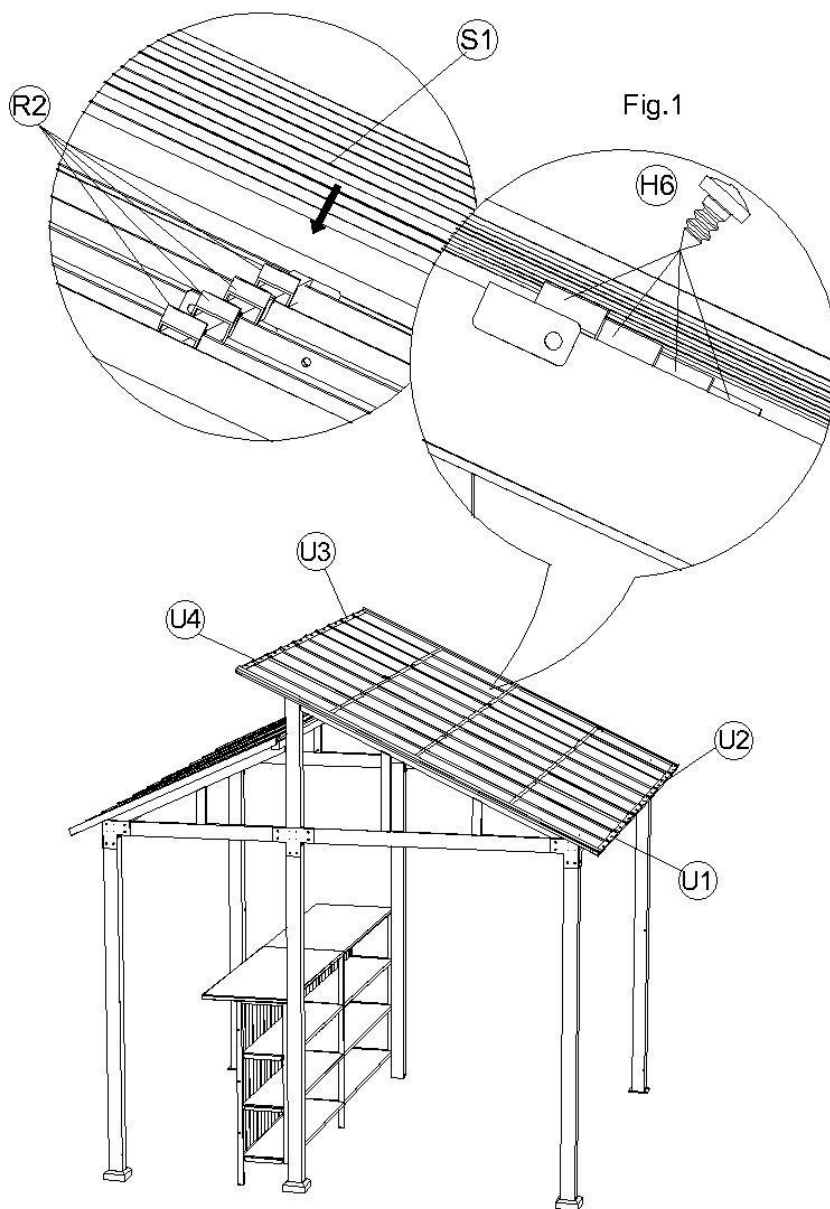

Fig.1

	S1 5X		U2 1X		U1 1X
	U3 1X		U4 1X		R2 4X

	H6		H1
4x		20x	





S2
5X



U1
1X



U2
1X

H1



10x

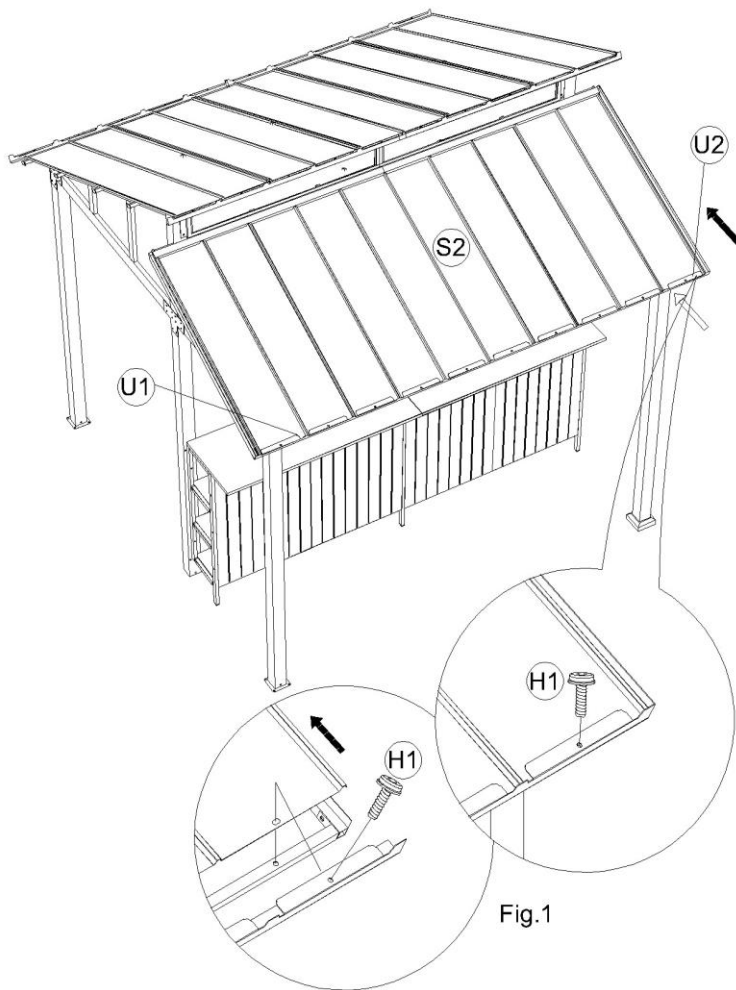









Fig.1

	U2 12X		U8 2X		U7 2X
	U4 2X		U3 2X		U6 1X
	U5 1X				

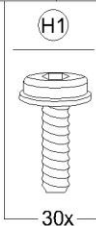

Fig.4

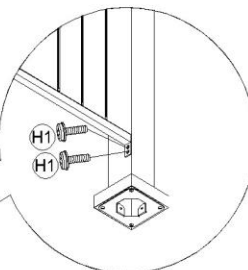
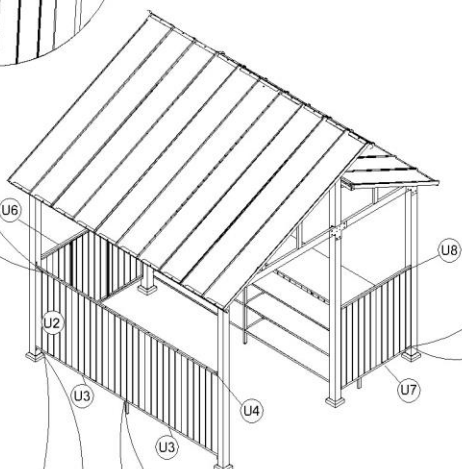

Fig.2

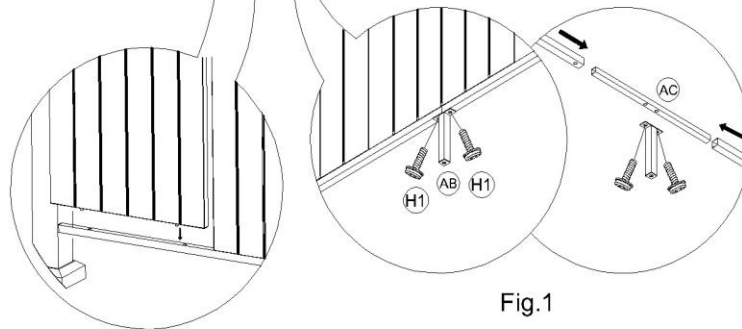
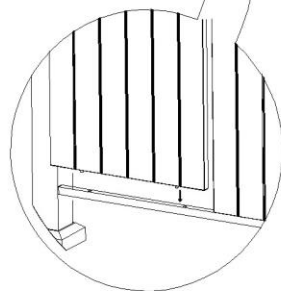

Fig.1

Fig.3





V
8X

(H1)

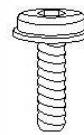

16x

Fig.2

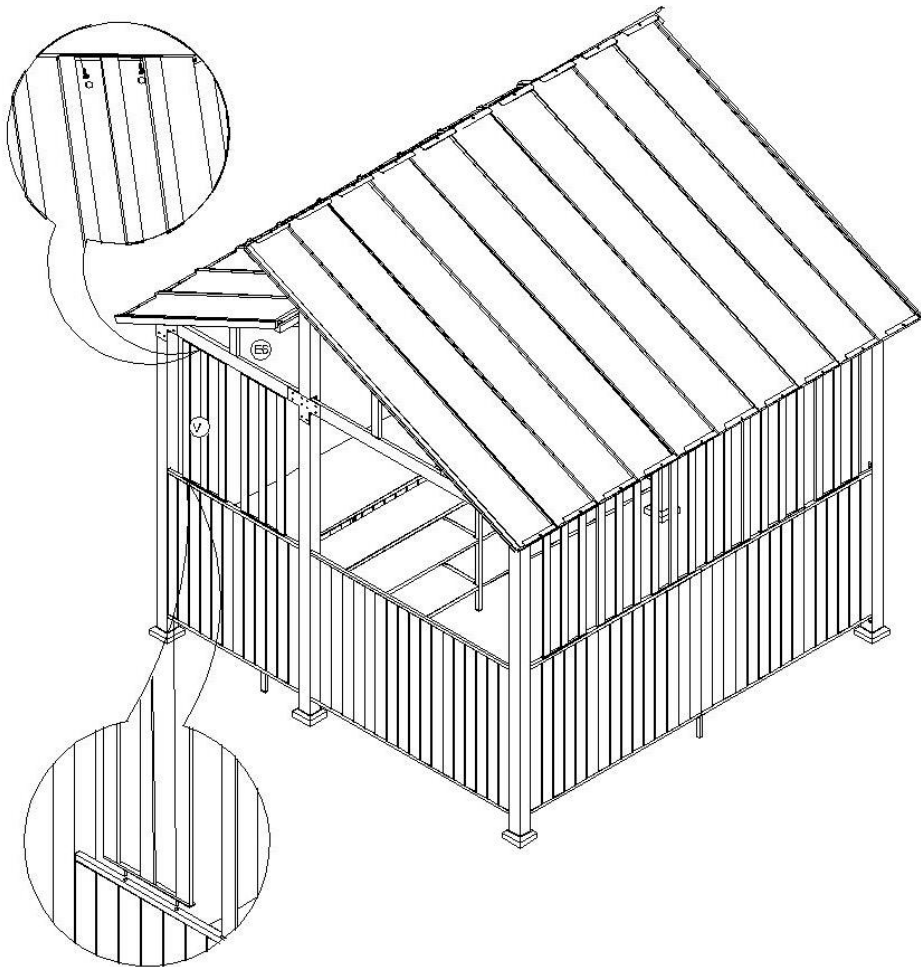
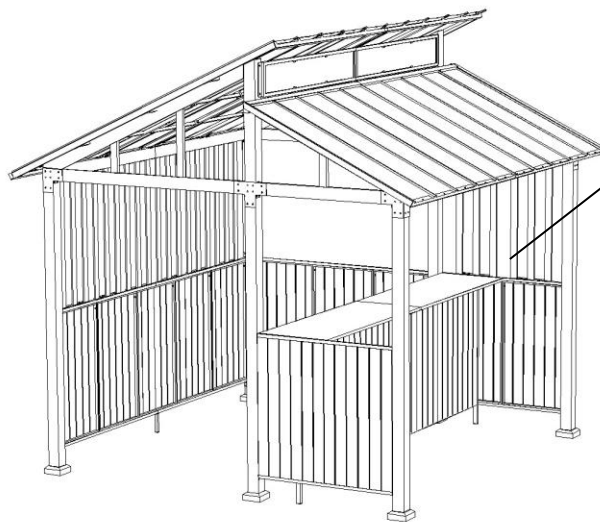
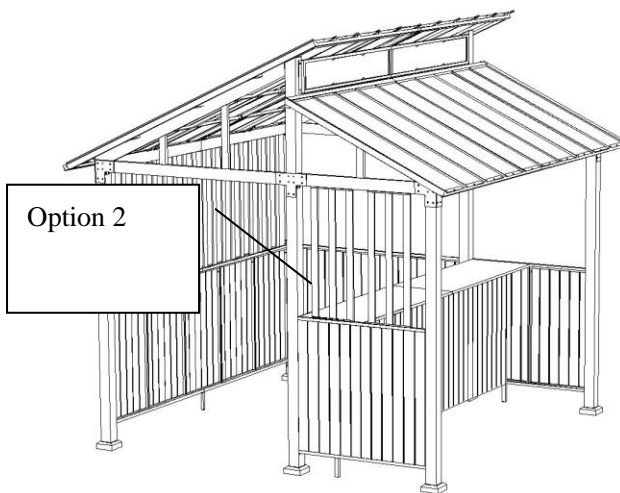

Fig.1



Option 1

OR



Option 2

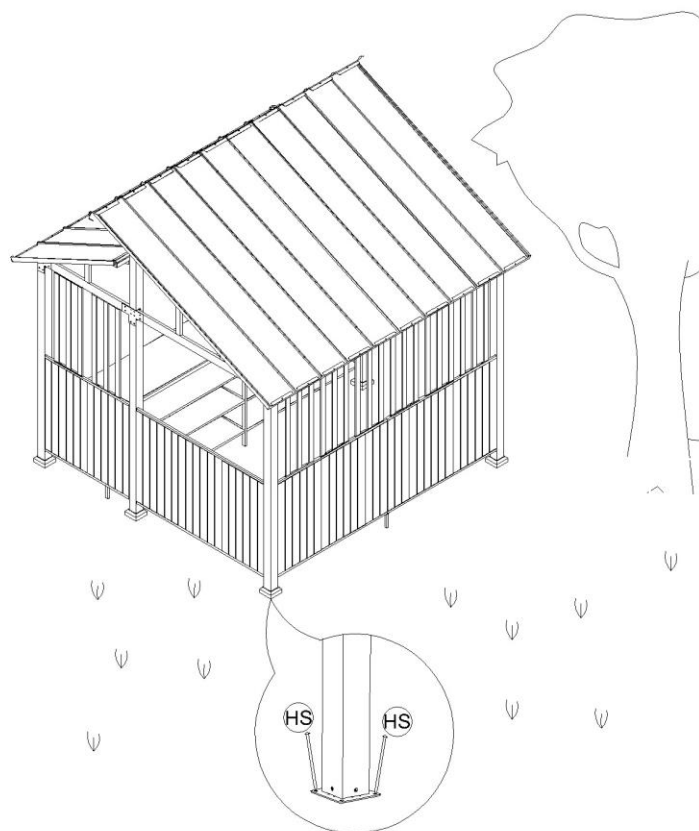
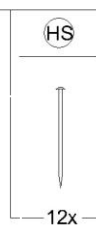

Barstool

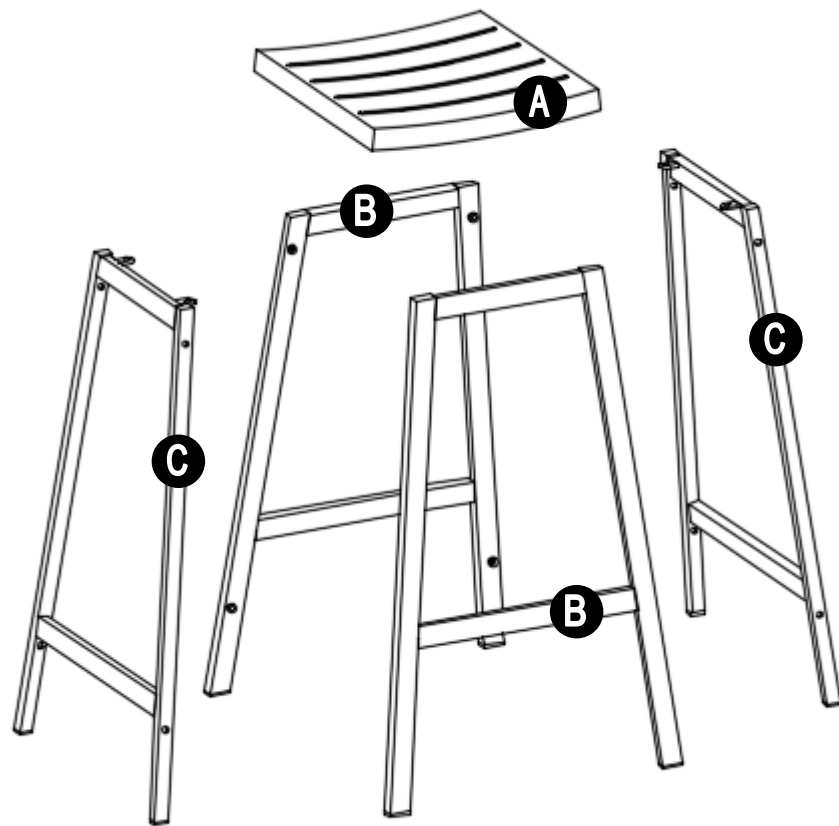

Parts List

No.	Description	Qty
A	Seat	1
B	Front/Back foot	2
C	Side foot	2
H1	Bolt M6*15	8
H2	Nut M6*25	4
H3	M6 Washer	12
HW	Wrench M6	1

B*2 + C*2

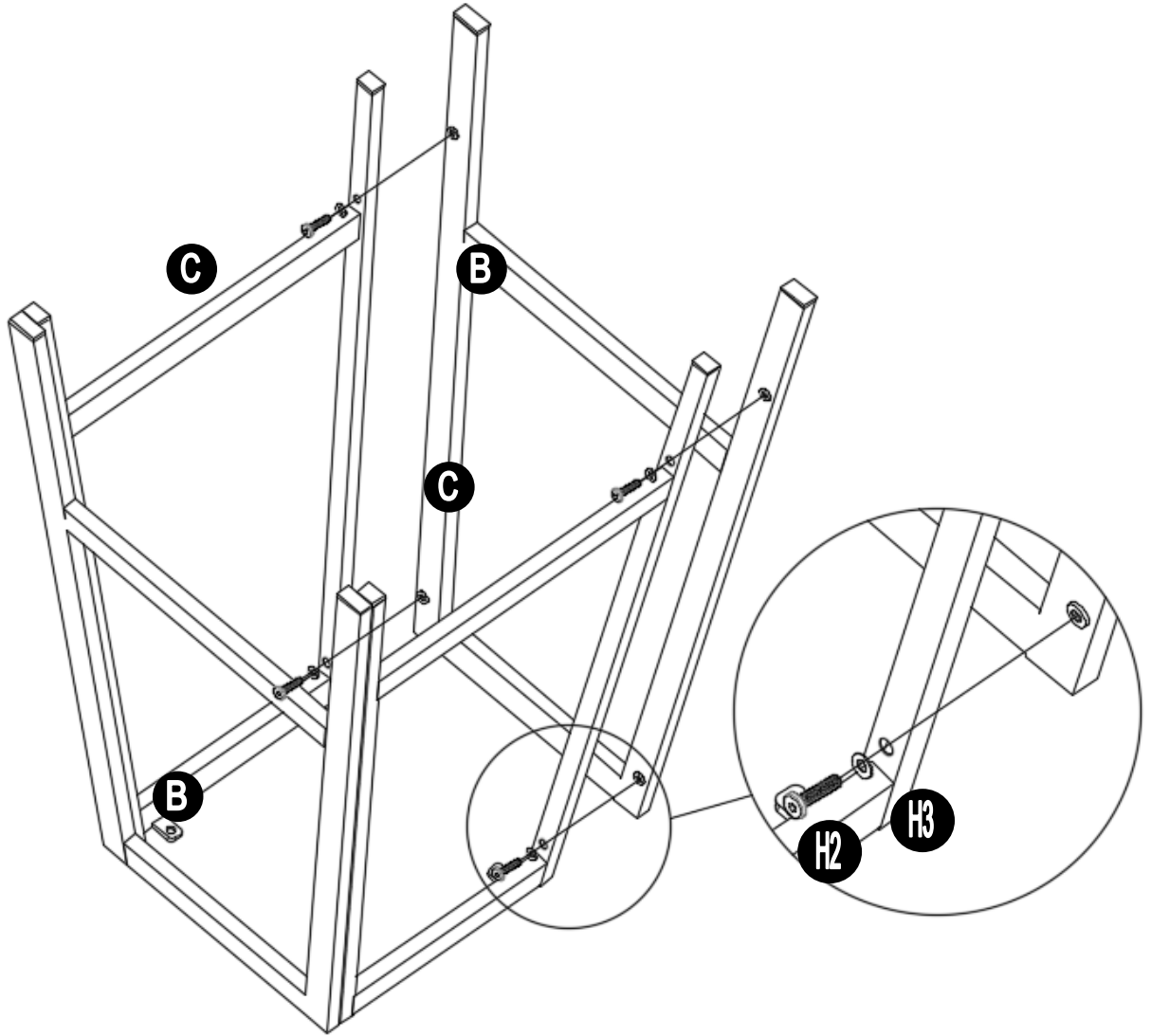

A*1

